



INSTALLATION INSTRUCTIONS

Product: Quicker Disconnects™

Part Number: JKS2000 - JKS2001 - JKS2002

Applications: Wrangler JK, 2007+ (front only)

Wrangler TJ, 1997-06 (front or rear)

Grand Cherokee ZJ, 1993-98 (front only)

517-278-1226 • jks@sporttruckusainc.com • www.jksmfg.com
491 W. Garfield Avenue, Coldwater, MI 49036

Welcome

CONGRATULATIONS on purchasing a set of new Quicker Disconnects™ from JKS Manufacturing. We are committed to providing you with the best products available and your satisfaction is our first priority.

PLEASE READ these Installation Instructions carefully, and save them for future reference, as they contain important installation and maintenance information.

Important

NOT COMPATIBLE WITH aftermarket swaybars. Install product with Original Equipment swaybar only.

SOME VEHICLES MAY REQUIRE extended front brake hoses or other modifications to compensate for additional suspension travel.

NEVER DISCONNECT swaybar when operating vehicle on public roads.

WHEN DISCONNECTED, swaybar must be secured to prevent interference with other suspension components or axle.

Tools Required

- Metric/Standard Socket Wrench Set
- (17mm and 3/4" sockets)
- Torque Wrench
- Tie Rod End Remover *
- 6mm Allen Head Socket
- 6mm Allen Wrench
- 1/4" Allen Wrench *
- 15/16" Open-End Wrench
- #1 Philips Screwdriver or Small Punch
- F" Drill Bit (0.257" equiv.) *
- 5/16" x 18TPI Tap *
- Angle Measuring Tool
- Grease Gun with Zerk Fitting Coupler
- Wheel Bearing Grease

* Asterisk denotes tools that are not required for some applications. Thoroughly read instructions first to determine which tools will be required for your application.

Parts

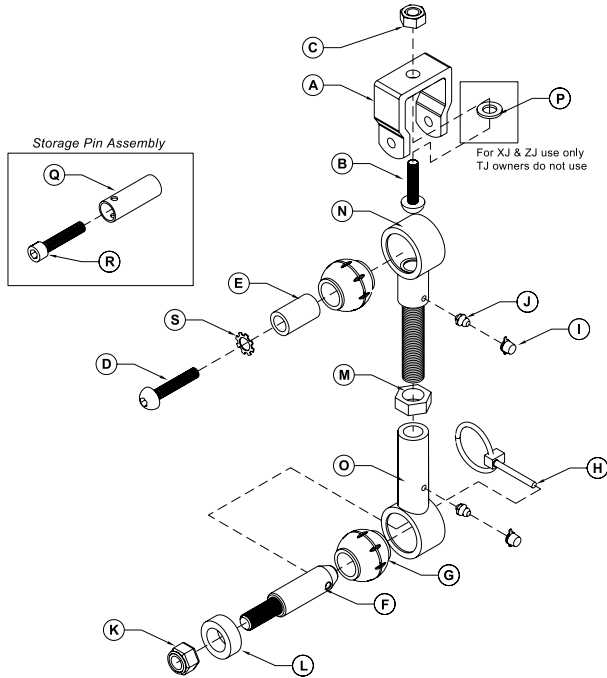

A	U-Strap
B	10mm x 35mm Button Head Bolt
C	10mm Nylock Nut
D	10mm x 50mm Button Head Bolt (with factory-applied thread locking compound)
E	1.25" Aluminum Sleeve
F	Stainless Steel Post
G	Spherical Bushing
H	Click Pin
I	Grease Zerk Cap
J	Press-In Grease Zerk
K	1/2" NF Nylock Nut
L	Offset Polyurethane Spacer
M	5/8" Jam Nut
N	Upper Male Threaded End
O	Lower Female Threaded End
P	Flat Washer
Q	Storage Pin
R	5/16" x 1-1/2" NC Allen Bolt
S	10mm External Tooth Lock Washer

Installation

- ❑ 1. REMOVE ORIGINAL EQUIPMENT (OE) SWAYBAR LINKS\
 - Remove front swaybar drop links and mounting hardware per the factory service manual instructions for your vehicle. **HINT: If difficult to remove, use special factory removal tool PN MB991113 (Miller Special Tools, 800-801-5420) or similar tie rod end removal tool.**



- ❑ 2. INSTALL UPPER U-STRAPS
 - Mount U-Strap (A) on top of swaybar with threaded leg of U-Strap positioned inboard.

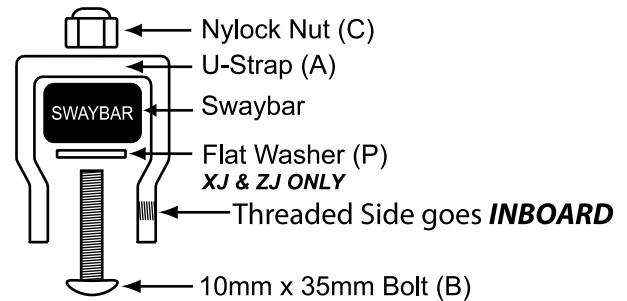

IMPORTANT: U-Strap must be mounted ABOVE swaybar, NOT BELOW

- Insert 10mm x 35mm Button Head Bolt (B) and Flat Washer (P) – only if required – upward through swaybar and U-Strap (A). Secure with 10mm Nylock Nut (C).

IMPORTANT: Flat Washers are supplied for use with 1984-01 Cherokee XJ and 1993-98 Grand Cherokee ZJ models ONLY. Do NOT use Flat Washer on Wrangler TJ models.



- Tighten 10mm Nylock Nut (C) to 40 ft-lb. using a torque wrench.

❑ 3. INSTALL LOWER TAPERED POST

- Remove the nut and insert the Stainless Steel Posts (F) into the lower swaybar link holes on the front axle. Position posts with tapered ends pointing inboard, ensuring small Click Pin holes are horizontal or parallel with the ground.
- Install 1/2" Nylock Nut (K) on outboard side of lower swaybar link brackets and tighten to 65 ft-lb. using a torque wrench.



HINT: A small Philips head screwdriver or punch inserted into the Click Pin hole will enable you to pre-

vent the tapered Stainless Steel Posts from rotating when tightening the Nylock nut.

❑ 4. SET QUICKER DISCONNECT LENGTH

- Determine the Ideal Swaybar Angle for your vehicle according to the following chart.

Vehicle	Part Number	Maximum Length *	Ideal Swaybar Angle (Acceptable Range)
ZJ Grand Cherokee	PN 2000	9-3/8"	10° (5°-15°)
	PN 2001	11-5/8"	
	PN 2002	7-1/8"	
XJ Cherokee	PN 2000	9-3/8"	15° (10°-20°)
	PN 2001	11-5/8"	
	PN 2002	7-1/8"	
TJ Wrangler	PN 2000	9-3/8"	10° (5°-15°)
	PN 2001	11-5/8"	

IMPORTANT: DO NOT exceed Maximum Length (measured from center-to-center of bushings) indicated for your part number.

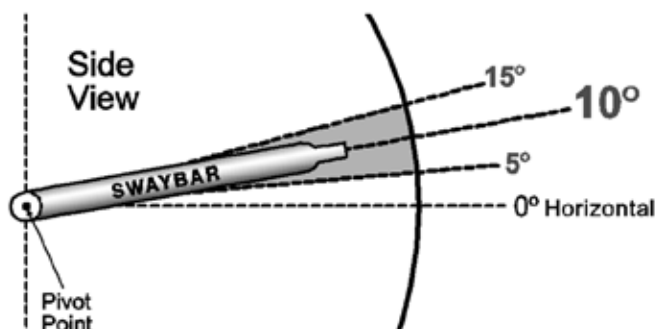

- Adjust the length of your Quicker Disconnects until swaybar is at the Ideal Angle or within Acceptable Range. Vehicle must be at normal ride height and located on level ground.

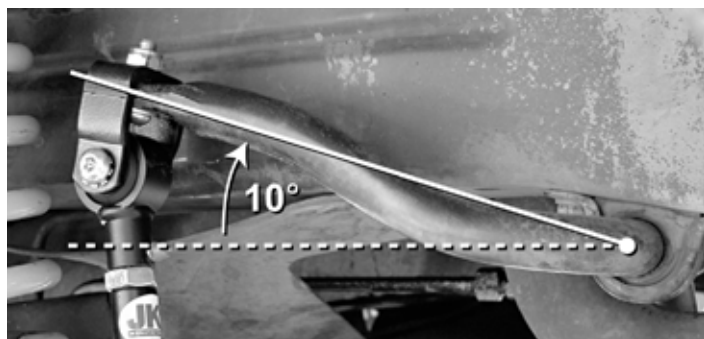

- Once adjusted, lay Quicker Disconnects on a flat surface and tighten Jam Nuts (M) firmly against the Lower Ends (O).

❑ 5. INSTALL QUICKER DISCONNECTS

- Locate the 10mm x 50mm Button Head Bolt (D) with factory-applied thread locking compound.
- Insert the Upper End (N) of Quicker Disconnect into U-Strap (A) and install 10mm x 50mm Button Head Bolt (D) with External Tooth Lock Washer (S).
- Tighten the 10mm x 50mm Button Head Bolt (D) to 40 ft-lb. using a torque wrench with 6mm Allen head socket.



- Slide Lower End (O) of Quicker Disconnect onto the tapered Stainless Steel Posts (F).
- Insert Click Pins (H) as illustrated to secure.

CORRECT

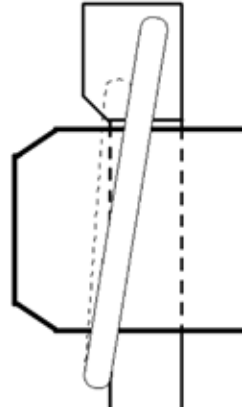

WRONG

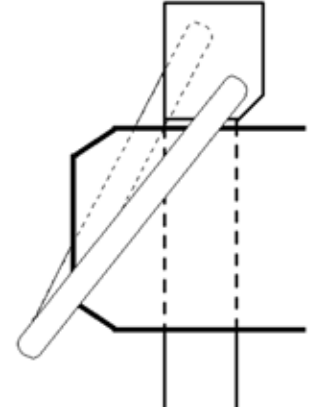

IMPORTANT: When properly installed, the ring on the Click Pin will “snap” against the shaft of pin. When installed backwards, the ring does not fit snugly against shaft.

❑ 6. INSTALL STORAGE PINS

The supplied Storage Pins (Q) can only be used on Wrangler TJ models, or Cherokee XJ / Grand Cherokee ZJ models equipped with OE front skid plate.

IMPORTANT: Storage Pins must be mounted in a location that will allow FULL suspension and steering travel WITHOUT tire interference.

TJ Models

- Locate mounting point for Storage Pins (Q) on chassis that allows Disconnect to reach it without adjustment. Using a size “F” drill bit, drill a hole in the outboard side of each chassis rail and tap with 5/16” x 18TPI tap.
- Install Storage Pins (Q) using the supplied 5/16” x 1-1/2” NC Allen Bolts (R).

XJ / ZJ Models (with OE Front Skid Plate)

- Locate mounting point for Storage Pins (Q) on OE Front Skid Plate that allows Disconnect to reach it without adjustment. Drill a 5/16” hole in outboard sides of skid plate.
- Install Storage Pins (Q) using the supplied 5/16” x 1-1/2” NC Allen Bolts (R) and 5/16” Nylock Nuts (not supplied).

XJ / ZJ Models (without OE Front Skid Plate)

- DO NOT INSTALL supplied Storage Pins (Q) on vehicle. Instead, swaybar and Quicker Disconnects may be secured to chassis with plastic wire ties or bungee cords (not supplied).

❑ 7. LUBRICATE QUICKER DISCONNECTS

- Lubricate all Grease Zerk fittings (J) on the Quicker Disconnects immediately after installation using common wheel bearing grease or equivalent.

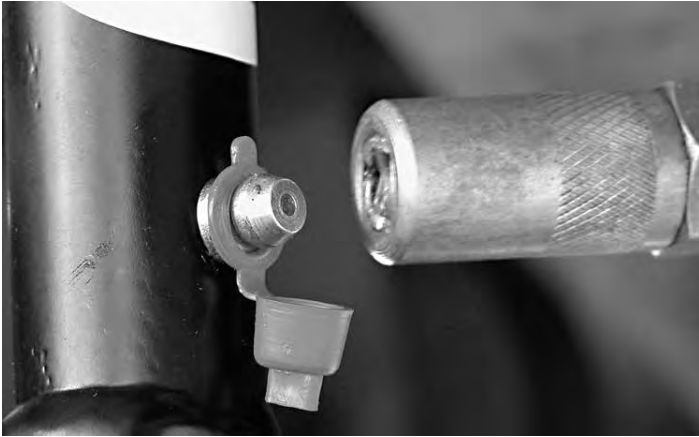

Troubleshooting

If swaybar does not rotate freely, remove from vehicle, clean and apply rubber lubricant to chassis-mounted bushings, and reinstall.

Contact between Quicker Disconnect U-Strap (A) and vehicle chassis on Wrangler TJ models usually indicates a misaligned swaybar caused by a front axle that is not centered. Take consistent measurements on each side of vehicle to confirm misalignment, and install JKS Adjustable Trackbar (available separately) to correct.

Maintenance

It is important to lubricate Quicker Disconnects frequently for the first three (3) months after installation to evacuate contaminants that may build up during break-in period.

After break-in period, Quicker Disconnects should be lubricated regularly as part of vehicle maintenance schedule.

Regular cleaning with pressurized water is recommended to maximize ease of operation and reliability. Always lubricate afterwards to evacuate any moisture.

©2017 JKS Manufacturing, Inc & Aftermarketing, LLC
Revision Date 7/28/2017