

JKS[®]

Installation Instructions

Product: **HD Extended Brake Lines**

Part Number: **PN 2292**

Applications: **Jeep Wrangler TJ, 1997-06**
Jeep Grand Cherokee ZJ, 1993-98
Jeep Cherokee XJ, 1984-01
Jeep Comanche MJ, 1986-92

Welcome

CONGRATULATIONS on purchasing new HD Extended Brake Lines from JKS Manufacturing. We are committed to providing you with the best products available and your satisfaction is our first priority.

PLEASE READ these Installation Instructions carefully, and save them for future reference, as they contain important installation and maintenance information.

Important

RECOMMENDED FOR vehicles lifted 4-6" only. Installation on vehicles with a lower ride height is possible, as long as installer properly secures the brake line to prevent interference with other components.

Tools Required

- Metric/Standard Socket Wrench Set
- 3/8" Wrench (Flare Nut or Open End) *
- 1/2" Wrench (Flare Nut or Open End) *
- 9/16" Open End Wrench
- 11/16" Open End Wrench
- T35 Torx Driver
- Torque Wrench
- Factory Service Manual (recommended)

* The original mounting bolt for the factory brake hose mounting bracket can vary by application.

Parts



	DESCRIPTION	QTY
A	HD Extended Brake Line	2
B	Copper Washer	4
C	Mounting Bracket	2
D	Retainer Clip	2

Installation

❑ 1. REMOVE ORIGINAL BRAKE HOSES

- Disconnect the hard metal brake tube from the original rubber brake hose that is attached to vehicle chassis. **HINT:** Plug the metal tube to prevent brake fluid from leaking.
- Remove the original brake hose mounting bracket from chassis and save original bolt.
- Disconnect the original rubber brake hose from the caliper. Discard both copper washers, but retain the original bolt.

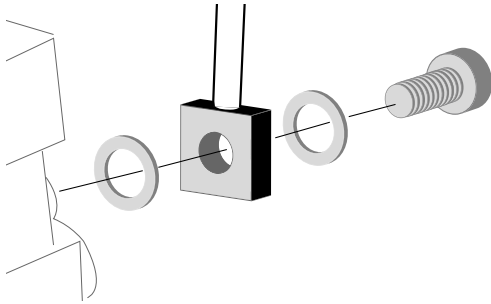

❑ 2. INSTALL NEW HD EXTENDED BRAKE LINES

- Attach gold end of HD Extended Brake Line (A) to caliper with new Copper Washers (B), and insert the original bolt.

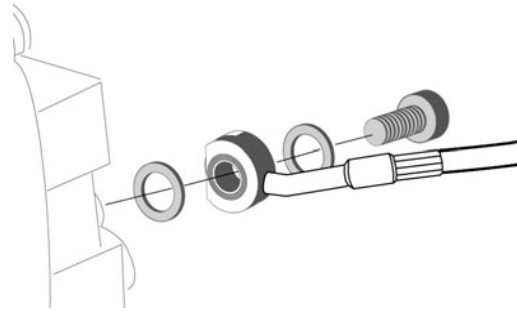
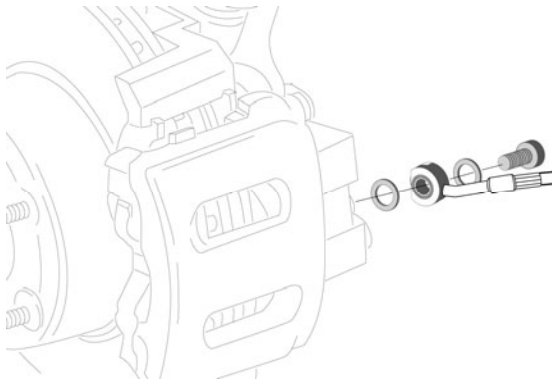

HINT: Install with new copper washers as indicated above. Brake line will only install with the “step” engaged on protruding portion of caliper. This prevents the brake line from rotating and ensures it will not contact the tire.

- Using a torque wrench, tighten the original bolt to 23 ft-lbs.
- Position the new brake line Mounting Bracket (C) in original location on chassis. **HINT:** On ABS equipped vehicles, make sure the mounting bracket for the ABS sensor wire also remains in the original location.
- Install new Mounting Bracket (C) to chassis using the original brake hose mounting bolt.
- Insert silver end of HD Extended Brake Line (A) into Mounting Bracket (C) and secure with the supplied Retainer Clip (D).
- Attach the original hard metal brake tube to silver end of HD Extended Brake Line (A) and tighten securely.

❑ 3. BLEED FRONT BRAKES

- Refill the master cylinder reservoir with the approved brake fluid.
- Bleed the front brakes per the factory service manual instructions for your vehicle.

❑ 4. POST-INSTALLATION

- Check brake lines to ensure they do not interfere with tires or any moving parts. Brake lines should also be checked at maximum suspension extension (droop) to ensure length is sufficient. **HINT:** On vehicles lifted less than 4.0”, it may be necessary to secure the brake line away from any other components.
- Check all hardware to ensure it has been correctly installed and tightened to factory torque specifications.

Maintenance

Check torque specifications as part of regular vehicle maintenance schedule.

© 2012 JKS Manufacturing, Inc & Aftermarketing, LLC
Revision Date 8/7/2012